



micRun® System

The ultimate precision toolholding system

Product catalog

REGO-FIX 

Providing solutions for cutting-edge tool clamping

Product offering	4
Medical engineering with micRun®	6

1.0 MR colletholders**Minimize runout – boost productivity 11**

1.0 MR colletholders	
1.1 SK interface	12
1.2 BT interface	14
1.3 HSK interface	16
1.4 Cylindrical (CYL) interface	20

2.0 MR collets**Successful high precision clamping 23**

2.1 MR collets	25
----------------	----

3.0 MR clamping nuts and disks**Innovative products fitting your needs 29**

3.1 Clamping nuts	
Hi-Q® MR/MRC	31
Hi-Q® MRM/MRMC	31
3.2 Disks	
3.2.1 Sealing disks DS	32
3.2.2 Coolant flush disks KS	38

4.0 micRun® accessories	42
-------------------------	----

5.0 Technical information	48
---------------------------	----

Experience high-precision toolholding

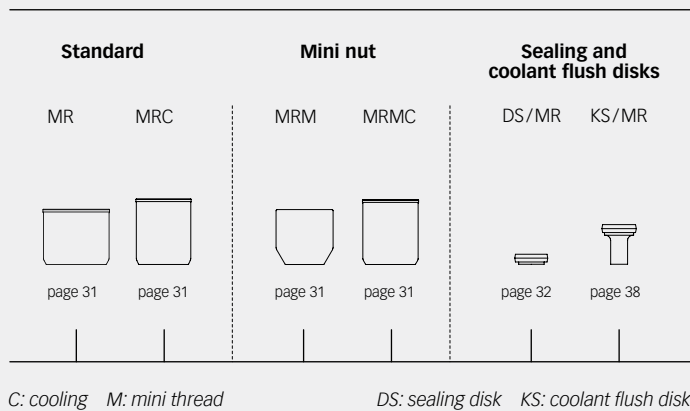
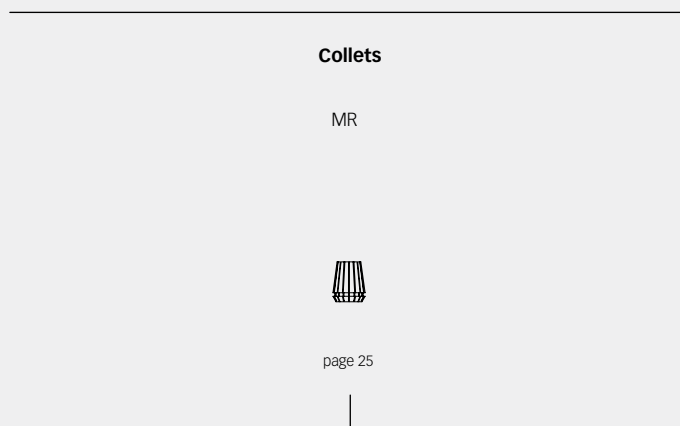
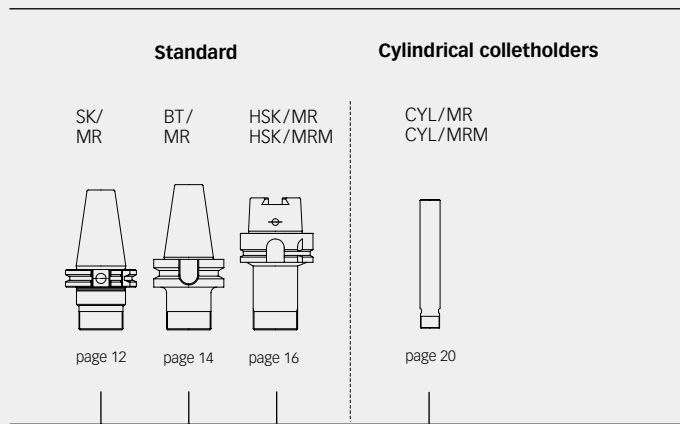

For torque wrenches and other accessories please refer to page 42.

Suitable for carbide or HSS milling cutter in all shank forms (Weldon, Whistle-Notch, etc.)

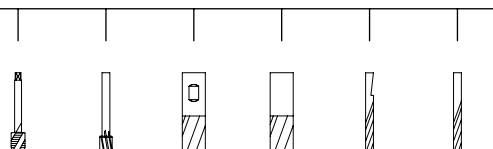



At a glance

Providing solutions for cutting-edge toolholding

Our holistic toolholding systems excel with extraordinary reliability, high precision and outstanding quality.

Pioneering spirit Fritz Weber, a Swiss master craftsman, tapped into the promising optimism in the 1950s and founded a small business called Fritz Weber Feinmechanik und Werkzeugbau. With his innovative spirit and stern determination, Fritz Weber gradually expanded his range of products. The company, now called REGO-FIX AG, achieved international recognition in 1972 with the invention of the ER clamping system, changing the toolholding industry forever. The ER System, made in Switzerland, is an industrial standard clamping element. It set the industry standard and even became DIN Standard (DIN 6499) in 1993. Today, the ER collet made by REGO-FIX is still the most used clamping collet worldwide.

Shaping the future REGO-FIX is an international family-owned company that is run by the sons of Fritz Weber. With its over 220 employees, REGO-FIX manufactures and markets high-precision toolholding systems worldwide. Headquartered in Tenniken, Switzerland, the company has established itself

as one of the leading manufacturers of toolholding systems and enjoys an excellent industry-wide reputation. Through its close network of distributors and subsidiaries in the US and China, REGO-FIX is strategically well positioned and possesses a worldwide presence in key markets. With groundbreaking product inventions, REGO-FIX developed from a small company to a global solution provider for cutting-edge toolholding systems. At the core of every product lies an aim for machining excellence and a passion for precision.

Cradle of precision REGO-FIX manufactures its products in Switzerland to fit highest quality standards. The products are used in the fields of automotive, aerospace, medical engineering, watchmaking, telecommunications and also in the die and mold industry.



micRun® System

Every micron counts

Closing the gap between the powRgrip® and the ER System, the micRun System convinces with a total system runout of $\leq 3 \mu\text{m}$.

Swiss high precision An excellent runout accuracy paired with low vibration not only increases your machining quality, but enhances your overall productivity and increases your tool life, thus successfully lowering your cutter costs. With a total system runout of $\leq 3 \mu\text{m}$ at $3 \times D$, the micRun® System provides all the benefits of excellent runout accuracy.

This is why micRun® is the ideal system for all micro machining applications and is successfully used in industries like watchmaking or medical engineering. In addition, our unique collet-locking system retains the collet safely inside the nut. This minimizes your risk of faulty operations or possible damages which may occur if the collet accidentally falls to the ground. Another great benefit of our collet-locking system is the tool-free removal of the collet.

Key advantages

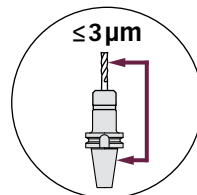

Total system TIR $\leq 3 \mu\text{m}$ at $3 \times D$.

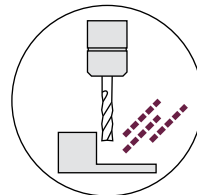

Designed for high-speed cutting.

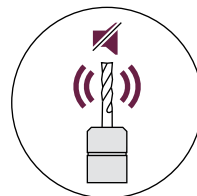

Silent and low vibration due to grooveless clamping nut.

Three systems – one brand

Our brand unites three different toolholding systems. Each system has different strengths to fit your machining needs, but at the heart of each system lies our aim for toolholding excellence.

powRgrip® System

For high-end machining with a total system **TIR ≤ 0.0001" (3 μm) at 3xD**

PG colletholders

Taper accuracy AT3

Surface finish
max. Ra 0.25

High transferable torque
up to 1,100 Nm

PG collets

Clamping range
from 0.0079" up to 1"

Special surface treatment
ensures longevity

Clamps all shanks
with tolerance h6

Vibration dampening
for high RPM

A holistic system approach

All parts are designed for exclusive fit to ensure toolholding excellence.

ER System

Our ideal system for standard machining

ER colletholders

Runout TIR ≤ 0.0001" (3 μm)

Taper accuracy AT3

Surface finish max. Ra 0.25

Factory balanced

ER collets

Wide clamping range: from ER 8 up to ER 50 and
for diameters from 0.0079" up to 1.375"

Clamping capacity 0.0197" to 0.0787"

Runout TIR ≤ 0.0004" (10 μm) at 3xD for ER standard

Runout TIR ≤ 0.0002" (5 μm) at 3xD for ER-UP

ER clamping nuts

Collet-locking system

Balanced by design

Special surface treatment improves transferable torque
and protects against corrosion

micRun® System

Total system TIR $\leq 0.0001"$ (3 μm) at 3xD

MR colletholders

Taper accuracy AT3

Polished surface for improved performance

Balanced for high RPM

Vibration dampening

MR collets

Clamping range from 0.0394" to 0.7874"

Nominal diameter shanks h11

MR clamping nuts

Collet-locking system

Balanced by design

Grooveless design for higher RPM

Freewheel wrench head

A holistic system approach

All parts are designed for exclusive fit to ensure toolholding excellence.



"In our professional environment, the winning combination of REGO-FIX torque wrench and freewheel wrench head enables our employees to properly clamp drilling and milling tools fast and with repeated accuracy."

Felix Fischler Founder of Fischler Camtech AG

Medical engineering with micRun®

Clamp drilling and milling tools reliably with micRun

Tool changing in dental laboratories sets special requirements for the toolholding system. Discover how our customer mastered the challenge.

Challenging industry requirements The specially designed 5-axis machining centers have to switch between different tools frequently when carrying out abutments, splints, crowns, bridges and complete tooth replacements made of titanium, chromium-cobalt (CrCo), wax, PEEK and PMMA, as well as of zirconium, glass and mixed ceramics. Common toolholding systems with collets that are integrated directly into the machining centers have proven to be unfavorable.

Successful customer Dental laboratory Fischler Camtech AG in Möhlin, Switzerland, works successfully with the micRun toolholding system from REGO-FIX. Their collets are mounted into the small micRun®-HSK-collethead, which enables the tools to be preadjusted exactly and clamped with repeated accuracy. Furthermore, their CNC machines can exchange different drilling and milling tools from the magazine stations automatically in the motor milling spindle with speeds of up to 50,000 rpm.

Clean thing A particular benefit of the micRun toolholding system is the slim clamping nut that is smooth on the outside. Dust and small fragments cannot stick and the surface is easy to clean. So easy in fact that dental technicians can remove any dirt quickly and easily using fluid and by blowing it off from the three separate components – the toolholder, the collet and the clamping nut. Furthermore, the clamping nut has only small interfering contours. The drilling and milling tools that are inserted are clamped using a torque wrench that adjusts the clamping nut via freewheel wrench.

Excellent runout TIR The REGO-FIX torque wrench and freewheel wrench head enable Fischler Camtech employees to properly clamp drilling and milling tools fast and with repeated accuracy. Considering that dental technicians are usually not trained machinists and the simplicity of the assembly is a winning argument.



The properly assembled nuts then retain a reliable concentricity of 3 µm. They can therefore machine to the required accuracies and achieve the required surface quality. Furthermore, the high concentric precision reduces wear on the cutting edges significantly. The milling tools therefore have a noticeably longer tool life. In addition to the standard versions, the micRun nut is also available with a smaller outer diameter. Fischler Camtech uses this Hi-Q®/MRM version successfully in their production of small medical parts.

This slim variant is always convenient if minimal interfering contours are required. The slim design enables any geometry that has to be machined to be achieved without problems.

Alan Fastner Product Manager at REGO-FIX AG

At a glance

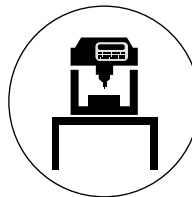

In high rpm office machines with low force and limited space, micRun® is the ideal well-balanced toolholding solution with low runout TIR.

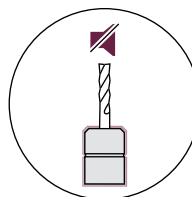

The smooth design and grooveless clamping nut allows for quiet machining and prevents abrasive dust from settling on the toolholder.

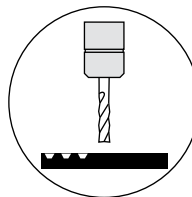





The slim micRun design is an important feature in milling small cavities where minimal interfering contours are mandatory.



**Customers from all around the world
rely on Swiss-made REGO-FIX products.
From Tenniken, we deliver customers
in fast-paced industries with
the highest demands for precision.**

We offer competitive solutions



Standard			Cylindrical colletholders
SK/ MR	BT/ MR	HSK/MR HSK/MRM	CYL/MR CYL/MRM
			
page 12	page 14	page 16	page 20



Minimize runout – boost productivity

Experience outstanding quality We at REGO-FIX know how to minimize your runout, increase quality and boost your productivity. This is why we designed our micRun® System to fulfill diverse criteria all crucial for achieving machining perfection.

The MR toolholder, collet and nut together make the micRun System a high-quality and high precision option for challenging machining applications such as watchmaking, micromachining and medical engineering. The micRun System has a TIR of 3 microns and is perfectly balanced for high-speed machining. The contours are slim and smooth which results in perfect, stable and quiet rotation in the machine.

What you see is what you get: all our products bear the REGO-FIX triangle – our seal for outstanding Swiss quality.



Swiss quality standard

Our products marked Swiss made are manufactured at our headquarters in Tenniken, Switzerland.

Steep taper colletholders SK

Universally suitable for different machining applications.

DIN 69871 / DIN ISO 7388-1

Features and benefits

Total system runout TIR $\leq 0.0001''$ (3 μm)

Our holistic system consists of an micRun[®] colletholder, collet and clamping nut. All components together ensure best runout and accuracy.

Colletholder runout TIR $\leq 1 \mu\text{m}$

Measured from inner taper to outer taper.

Taper accuracy AT3

Better spindle-to-holder fit and accuracy.

Surface finish max. Ra 0.25

Achieve high clamping force and high transferable torque.

Balancing

100 % balanced to G 2.5 @ 22,000 rpm.

MR clamping nut included in delivery

Guarantees highest clamping force and best balancing.

Vibration dampening

Our holders offer good vibration dampening to sustain a high surface finish and can help prevent chatter.



Type	Part no.	Dimensions [mm]		Accessory
		D	L	Freewheel wrench head
SK 30				
SK 30 / MR 16 x 050	5230.11610	28	50	A-FLS Ø 28 / MR 16
SK 30 / MR 16 x 100	5230.11650	28	100	A-FLS Ø 28 / MR 16
SK 30 / MR 25 x 070	5230.12530	40	70	A-FLS Ø 40 / MR 25
SK 40				
SK 40 / MR 11 x 100	5240.11150	16	100	A-FLS Ø 16 / MR 11
SK 40 / MR 16 x 070	5240.11630	28	70	A-FLS Ø 28 / MR 16
SK 40 / MR 16 x 100	5240.11650	28	100	A-FLS Ø 28 / MR 16
SK 40 / MR 16 x 160	5240.11680	28	160	A-FLS Ø 28 / MR 16
SK 40 / MR 25 x 070	5240.12530	40	70	A-FLS Ø 40 / MR 25
SK 40 / MR 25 x 100	5240.12550	40	100	A-FLS Ø 40 / MR 25
SK 40 / MR 25 x 160	5240.12580	40	160	A-FLS Ø 40 / MR 25
SK 40 / MR 32 x 070	5240.13230	50	70	A-FLS Ø 50 / MR 32
SK 40 / MR 32 x 100	5240.13250	50	100	A-FLS Ø 50 / MR 32
SK 40 / MR 32 x 160	5240.13280	50	160	A-FLS Ø 50 / MR 32

Included in delivery: MR colletholders come with HI-Q® / MR clamping nut.

Accessories are not included in delivery.

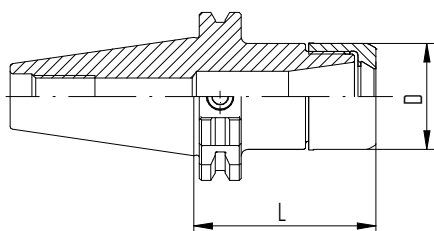

SK / MR (form A+AD)

Expert advice

We recommend tightening the clamping nuts using a torque wrench.

For tightening torque recommendations, please refer to page 50.

Steep taper colletholders BT

Universally suitable different machining applications, the BT interface colletholders cater to different machining needs.

MAS 403 / JIS B 6339 / DIN ISO 7388-2

Features and benefits

Total system runout TIR $\leq 0.0001''$ (3 μm)

Our holistic system consists of an micRun® colletholder, collet and clamping nut. All components together ensure best runout and accuracy.

Colletholder runout TIR $\leq 1 \mu\text{m}$

Measured from inner taper to outer taper.

Taper accuracy AT3

Better spindle-to-holder fit and accuracy.

Surface finish max. Ra 0.25

Achieve high clamping force and high transferable torque.

Balancing

100 % balanced to G 2.5 @ 22,000 rpm.

MR clamping nut included in delivery

Guarantees highest clamping force and best balancing.

Vibration dampening

Our holders offer good vibration dampening to sustain a high surface finish and can help prevent chatter.



Type	Part no.	Dimensions [mm]		Accessory
		D	L	Freewheel wrench head
BT 30				
BT 30 / MR 11 x 050	5130.11110	16	50	A-FLS Ø 16 / MR 11
BT 30 / MR 11 x 100	5130.11150	16	100	A-FLS Ø 16 / MR 11
BT 30 / MR 16 x 050	5130.11610	28	50	A-FLS Ø 28 / MR 16
BT 30 / MR 16 x 080	5130.11640	28	80	A-FLS Ø 28 / MR 16
BT 30 / MR 16 x 100	5130.11650	28	100	A-FLS Ø 28 / MR 16
BT 30 / MR 25 x 060	5130.12520	40	60	A-FLS Ø 40 / MR 25
BT 30 / MR 25 x 100	5130.12550	40	100	A-FLS Ø 40 / MR 25
BT 30 / MR 32 x 060	5130.13220	50	60	A-FLS Ø 50 / MR 32
BT 40				
BT 40 / MR 11 x 100	5140.11150	16	100	A-FLS Ø 16 / MR 11
BT 40 / MR 16 x 070	5140.11630	28	70	A-FLS Ø 28 / MR 16
BT 40 / MR 16 x 100	5140.11650	28	100	A-FLS Ø 28 / MR 16
BT 40 / MR 25 x 070	5140.12530	40	70	A-FLS Ø 40 / MR 25
BT 40 / MR 25 x 100	5140.12550	40	100	A-FLS Ø 40 / MR 25
BT 40 / MR 32 x 070	5140.13230	50	70	A-FLS Ø 50 / MR 32
BT 40 / MR 32 x 100	5140.13250	50	100	A-FLS Ø 50 / MR 32

Included in delivery: MR colletholders come with HI-Q® / MR clamping nut.

Accessories are not included in delivery.

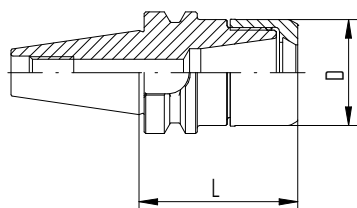

BT / MR (form A+AD)

Expert advice

We recommend tightening the clamping nuts using a torque wrench.

For tightening torque recommendations, please refer to page 50.

HSK colletholders

Designed for rotating applications, all our HSK colletholders are suited for high-speed applications where a consistent performance is key.

DIN 69893 / ISO 12164

Features and benefits

Total system runout TIR $\leq 0.0001''$ (3 μm)

Our holistic system consists of an micRun[®] colletholder, collet and clamping nut. All components together ensure best runout and accuracy.

Colletholder runout TIR $\leq 1 \mu\text{m}$

Measured from inner taper to outer taper.

Surface finish max. Ra 0.25

Achieve high clamping force and high transferable torque.

Balancing

100 % balanced to G 2.5 @ 25,000 rpm.

MR clamping nut included in delivery

Guarantees highest clamping force and best balancing.

Vibration dampening

Our holders offer good vibration dampening to sustain a high surface finish and can help prevent chatter.

Expert advice

For all HSK-A and HSK-E form colletholders a range of coolant tubes (KSR) is available.

For KSR part numbers please refer to page 46.



HSK forms and their key characteristics

HSK

DIN 69893

ISO 12164

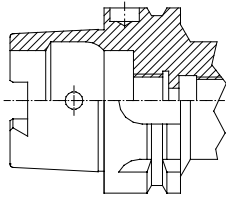

Form A*

- // Standard type for machining centers and milling machines
- // For automatic tool change
- // Coolant supply through center via coolant tube
- // Drive keys at the end of HSK taper
- // Hole for data carrier DIN STD 69873 in the flange is available on request

* Also usable in form C applications with side hole for manual tool change.

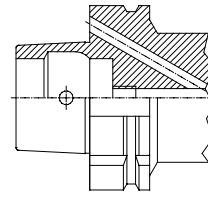

Form B

- // For machining centers, milling and turning machines
- // With enlarged flange size for higher radial rigidity
- // For automatic tool change
- // Coolant supply through the flange
- // Drive keys at the flange

Available on request.

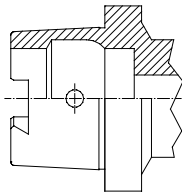

Form C

- // For transfer lines, special machines and modular tooling systems
- // For manual tool change
- // Drive keys at the end of HSK taper

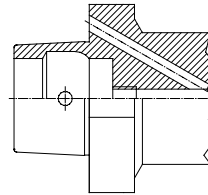

Form D

- // For special machines
- // With enlarged flange size for higher radial rigidity
- // For manual tool change
- // Coolant supply through the flange
- // Drive keys at the flange

Available on request.

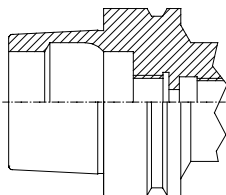

Form E

- // For high-speed applications
- // For automatic tool change
- // Coolant supply through center via coolant tube
- // Without any drive keys for absolute symmetry

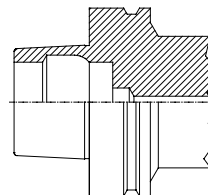

Form F

- // For high-speed applications
- // For automatic tool change
- // With enlarged flange size for higher radial rigidity
- // Without any drive keys for absolute symmetry

Type	Part no.	Dimensions [mm]		Accessory
		D	L	Freewheel wrench head
HSK-A 32				
HSK-A 32 / MRM 16 x 060	5532.11620	24	60	A-FLS Ø 24 / MRM 16
HSK-A 32 / MRM 16 x 100	5532.11650	24	100	A-FLS Ø 24 / MRM 16
HSK-A 40				
HSK-A 40 / MR 16 x 060	5540.11620	28	60	A-FLS Ø 28 / MR 16
HSK-A 40 / MR 16 x 100	5540.11650	28	100	A-FLS Ø 28 / MR 16
HSK-A 40 / MR 25 x 080	5540.12540	40	80	A-FLS Ø 40 / MR 25
HSK-A 50				
HSK-A 50 / MR 16 x 100	5550.11650	28	100	A-FLS Ø 28 / MR 16
HSK-A 50 / MR 25 x 080	5550.12540	40	80	A-FLS Ø 40 / MR 25
HSK-A 63				
HSK-A 63 / MR 11 x 100	5563.11150	16	100	A-FLS Ø 16 / MR 11
HSK-A 63 / MR 16 x 100	5563.11650	28	100	A-FLS Ø 28 / MR 16
HSK-A 63 / MR 25 x 080	5563.12540	40	80	A-FLS Ø 40 / MR 25
HSK-A 63 / MR 32 x 070	5563.13230	50	70	A-FLS Ø 50 / MR 32
HSK-A 63 / MR 32 x 100	5563.13250	50	100	A-FLS Ø 50 / MR 32

Included in delivery: MR colletholders come with Hi-Q® / MR clamping nut.

HSK-A: Hole for data carrier DIN STD 69873 in the flange available on request. Accessories are not included in delivery.

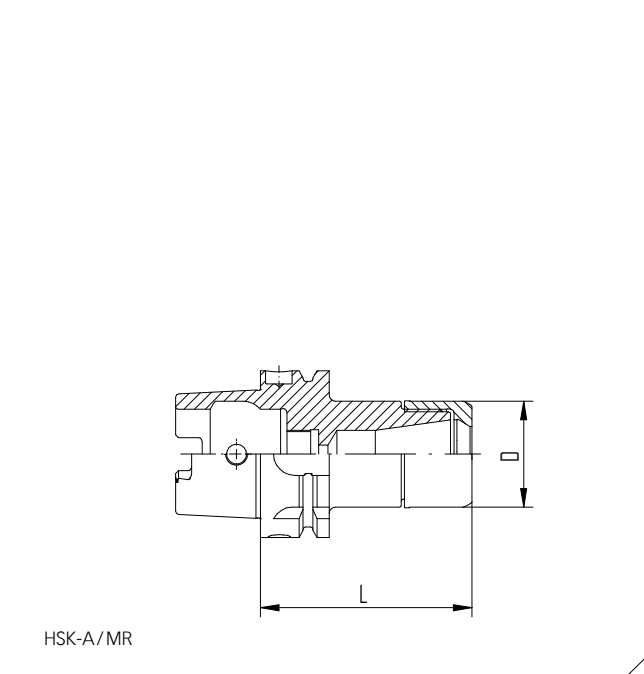

Type	Part no.	Dimensions [mm]		Accessory
		D	L	Freewheel wrench head
HSK-E 25				
HSK-E 25 / MR 11 x 045	5525.11114	16	45	A-FLS Ø 16 / MR 11
HSK-E 25 / MRM 16 x 045	5525.11618	24	45	A-FLS Ø 24 / MRM 16
HSK-E 32				
HSK-E 32 / MR 11 x 060	5532.11124	16	60	A-FLS Ø 16 / MR 11
HSK-E 32 / MRM 16 x 055	5532.11618	24	55	A-FLS Ø 24 / MRM 16
HSK-E 40				
HSK-E 40 / MR 11 x 050	5540.11114	16	50	A-FLS Ø 16 / MR 11
HSK-E 40 / MR 11 x 100	5540.11154	16	100	A-FLS Ø 16 / MR 11
HSK-E 40 / MRM 16 x 055	5540.11618	24	55	A-FLS Ø 24 / MRM 16
HSK-E 40 / MRM 16 x 080	5540.11648	24	80	A-FLS Ø 24 / MRM 16
HSK-E 40 / MR 25 x 065	5540.12520	40	65	A-FLS Ø 40 / MR 25
HSK-E 50				
HSK-E 50 / MR 16 x 100	5550.11654	28	100	A-FLS Ø 28 / MR 16
HSK-E 50 / MR 25 x 070	5550.12534	40	70	A-FLS Ø 40 / MR 25

Included in delivery: MR colletholders come with HI-Q® / MR clamping nut.

Accessories are not included in delivery.

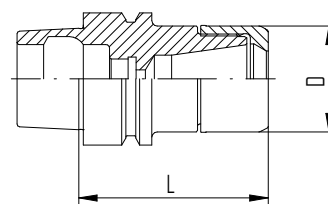

Cylindrical shank colletholders CYL

CYL

Features and benefits

Total system runout TIR $\leq 0.0001''$ (3 μm)

Our holistic system consists of an micRun® colletholder, collet and clamping nut. All components together ensure best runout and accuracy.

Colletholder runout TIR $\leq 1 \mu\text{m}$

Measured from inner taper to cylindrical shank.

Surface finish max. Ra 0.25

Achieve high clamping force and high transferable torque.

Sizes

CYL / MR 11 and CYL / MRM 16

Application

CYL / MR is suited for Swiss automatic machines, machining centers and conventional machines.

MR clamping nut included in delivery

Guarantees maximum precision.

Vibration dampening

Our holders offer good vibration dampening to sustain a high surface finish and can help prevent chatter.

Expert advice

We recommend tightening the clamping nuts using a torque wrench.

For tightening torque recommendations, please refer to page 50.



Type	Part no.	Dimensions [mm]				G	Accessory
		D	L	L1	L2		Freewheel wrench head
CYL 16							
CYL 16 x 150 / MR 11	5616.11190	16	150	17.2	20	M 8 x 1	A-FLS Ø 16 / MR 11
CYL 16 x 200 / MR 11	5616.11100	16	200	17.2	20	M 8 x 1	A-FLS Ø 16 / MR 11
CYL 20							
CYL 20 x 150 / MRM 16	5620.21690	24	150	25.2	25	M 12 x 1	A-FLS Ø 24 / MRM 16
CYL 20 x 200 / MRM 16	5620.21600	24	200	25.2	25	M 12 x 1	A-FLS Ø 24 / MRM 16

Included in delivery: MR collet holders come with Hi-Q® / MR clamping nut.

Accessories are not included in delivery.

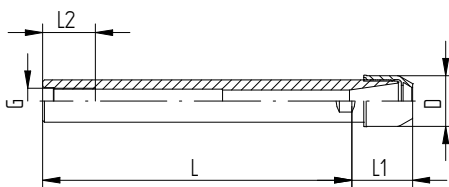

CYL/MR



Collets

MR



page 25



Successful high-precision clamping

Combine our MR colletholders with our MR collets to ensure maximum precision and best balancing to maximize your tool life.

Experience the quality of the triangle The outstanding design paired with our experienced engineering make the MR products one of our most accurate toolholding options. What you see is what you get: all our products bear the REGO-FIX triangle – our seal for outstanding Swiss quality.

Key advantages

Rely on the original

Wide clamping range

The 16-slot design allows for a wide clamping range with a continuing best TIR.

Broad range of products

We offer sizes from MR 11 up to MR 32 and diameters from 1 mm up to 20 mm.

Up to 20% more clamping length

Improve your runout with up to 20% more clamping length in smaller diameters.

Matched tooling system for best fit

The compatibility of the entire system results in maximum precision, balance and tool life.



Swiss quality standard

Our products marked Swiss made are manufactured at our headquarters in Tenniken, Switzerland.

Finest quality deserves best treatment

Correct assembly increases your collet life and ensures low runout TIR.

Assembly instructions for MR collets

- // Insert collet groove into the eccentric ring of the clamping nut at the mark on the bottom of the nut
- // Push the collet in the direction of the arrow until it clicks in place
- // Screw the nut with the collet onto the colletcher
- // We recommend to tighten the nut with a torque wrench

For recommended tightening torque please refer to list on page 50.

Disassembly instructions After the nut is unscrewed from the colletcher, press on the face of the collet while simultaneously pushing sideways on the back of the collet opposite the mark, until it disengages from the clamping nut.

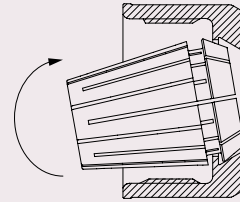

Assembling

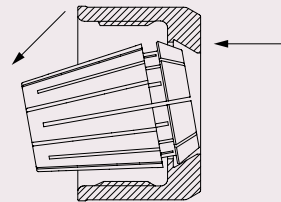

Disassembling

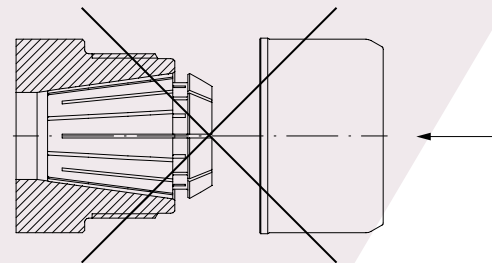

Expert advice

Improper assembly can permanently damage the runout TIR of the collet and may result in the destruction of the clamping nut. Only mount clamping nuts with correctly assembled collets.

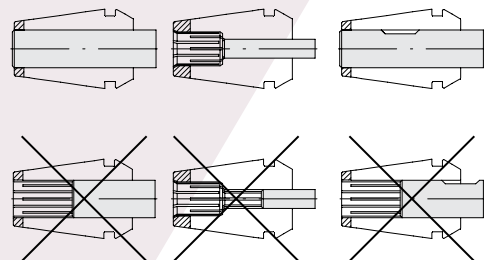

Type	Part no.	Ø	
		[mm]	[inch]
MR 11 [mm]			
Ø 1.0 mm	1111.01006	1.0	–
Ø 2.0 mm	1111.02006	2.0	–
Ø 3.0 mm	1111.03006	3.0	–
Ø 4.0 mm	1111.04006	4.0	–
Ø 5.0 mm	1111.05006	5.0	–
Ø 6.0 mm	1111.06006	6.0	–

MR 11 [inch]			
Ø 1/8"	1111.03186	3.175	1/8"
Ø 3/16"	1111.04766	4.763	3/16"
Ø 1/4"	1111.06356	6.35	1/4"

MR 16 [mm]			
Ø 1.0 mm	1116.01006	1.0	–
Ø 2.0 mm	1116.02006	2.0	–
Ø 3.0 mm	1116.03006	3.0	–
Ø 4.0 mm	1116.04006	4.0	–
Ø 5.0 mm	1116.05006	5.0	–
Ø 6.0 mm	1116.06006	6.0	–
Ø 8.0 mm	1116.08006	8.0	–
Ø 10.0 mm	1116.10006	10.0	–

MR 16 [inch]			
Ø 1/8"	1116.03186	3.175	1/8"
Ø 3/16"	1116.04766	4.763	3/16"
Ø 1/4"	1116.06356	6.35	1/4"
Ø 5/16"	1116.07946	7.938	5/16"
Ø 3/8"	1116.09536	9.525	3/8"

Type	Part no.	Ø [mm]	Ø [inch]
MR 25 [mm]			
Ø 1.0 mm	1125.01006	1.0	–
Ø 2.0 mm	1125.02006	2.0	–
Ø 3.0 mm	1125.03006	3.0	–

Type	Part no.	[mm]	Ø [inch]
MR 25 [mm] continued			
Ø 4.0 mm	1125.04006	4.0	–
Ø 5.0 mm	1125.05006	5.0	–
Ø 6.0 mm	1125.06006	6.0	–
Ø 8.0 mm	1125.08006	8.0	–
Ø 10.0 mm	1125.10006	10.0	–
Ø 12.0 mm	1125.12006	12.0	–
Ø 14.0 mm	1125.14006	14.0	–
Ø 16.0 mm	1125.16006	16.0	–

MR 25 [inch]			
Ø 1/8"	1125.03186	3.175	1/8"
Ø 1/4"	1125.06356	6.35	1/4"
Ø 5/16"	1125.07946	7.938	5/16"
Ø 3/8"	1125.09536	9.525	3/8"
Ø 7/16"	1125.11116	11.113	7/16"
Ø 1/2"	1125.12706	12.7	1/2"
Ø 9/16"	1125.14296	14.288	9/16"
Ø 5/8"	1125.15886	15.875	5/8"

MR 32 [mm]			
Ø 2.0 mm	1132.02006	2.0	–
Ø 3.0 mm	1132.03006	3.0	–
Ø 4.0 mm	1132.04006	4.0	–
Ø 5.0 mm	1132.05006	5.0	–
Ø 6.0 mm	1132.06006	6.0	–
Ø 8.0 mm	1132.08006	8.0	–
Ø 10.0 mm	1132.10006	10.0	–
Ø 12.0 mm	1132.12006	12.0	–
Ø 14.0 mm	1132.14006	14.0	–
Ø 16.0 mm	1132.16006	16.0	–
Ø 18.0 mm	1132.18006	18.0	–
Ø 20.0 mm	1132.20006	20.0	–

Type	Part no.	[mm]	Ø [inch]
MR 32 [inch]			
Ø 1/4"	1132.06356	6.35	1/4"
Ø 5/16"	1132.07946	7.938	5/16"
Ø 3/8"	1132.09536	9.525	3/8"
Ø 7/16"	1132.11116	11.113	7/16"
Ø 1/2"	1132.12706	12.7	1/2"
Ø 9/16"	1132.14296	14.288	9/16"
Ø 5/8"	1132.15886	15.875	5/8"
Ø 11/16"	1132.17466	17.463	11/16"
Ø 3/4"	1132.19056	19.05	3/4"



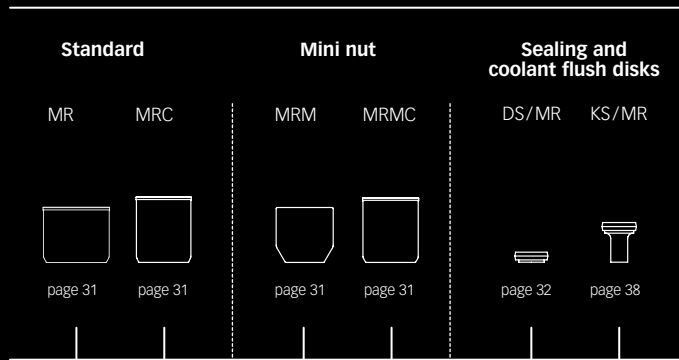

C: cooling M: mini thread

DS: sealing disk KS: coolant flush disk

Innovative products fitting your needs

We offer a wide selection of MR clamping nuts for virtually any application.

Key advantages

Rely on micRun®

Collet-locking system (pat. pend.)

Retains collet in nut for easier assembly.
Further, no tool is need to remove the collet.

Balancing

Ideal for high-speed applications.

Higher transferable torque

Lower frictional forces resulting in up to
80 % higher gripping force over standard nontreated
clamping nuts.

Cooling available

Available with sealing disk for coolant through tools.

Suited for high-speed applications

The micRun® Hi-Q clamping nut is suited for high rpm.

Long life

Our micRun® Hi-Q clamping nuts come without
a delicate ball bearing.

Quiet machining

The grooveless micRun® Hi-Q clamping nuts
lower noise levels.

Strongest clamping

A fine thread instead of a ball bearing together with
a low friction design make our micRun® Hi-Q clamping
nuts one of the best high-precision clamping nuts on
the market.



Swiss quality standard

Our products marked Swiss made
are manufactured at our headquarters
in Tenniken, Switzerland.

Proper assembly protects your runout TIR

Assembly instructions for MR clamping nuts

- // Click the collet in the nut and experience the power of the unique collet-locking system
- // Put the tool in the collet (minimum insertion length should be $\frac{2}{3}$ of the collet length, only norm size shafts may be used; never clamp over- or undersized shafts)
- // Put the nut, collet and tool combination on the collethead using the correct mounting block interface adapter
- // Use the correct freewheel wrench head A-FLS with the smallest torque wrench that can be used for the correct amount of torque needed for this MR nut in combination with the MR collet and the specific tool shank size

For recommended tightening torque please refer to list on page 50.

Disassembly instructions After the nut is unscrewed from the collethead, press on the face of the collet while simultaneously pushing sideways on the back of the collet opposite the mark, until it disengages from the clamping nut.

Expert advice

We recommend the use of REGO-FIX torque wrenches to prevent any damages to the MR nut.

For recommended REGO-FIX accessories, please refer to page 42.

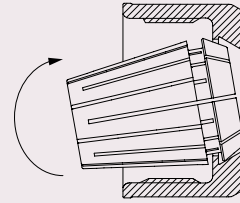

Assembling

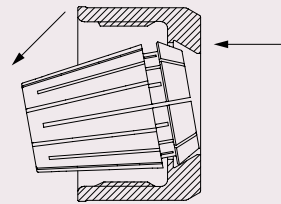

Disassembling

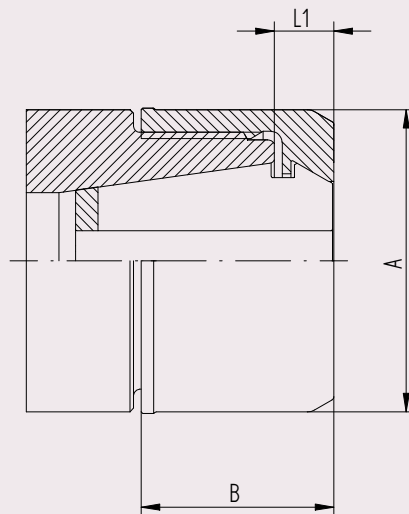
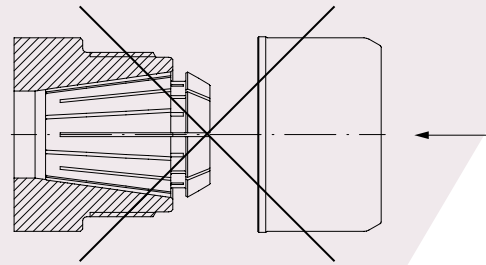

MR

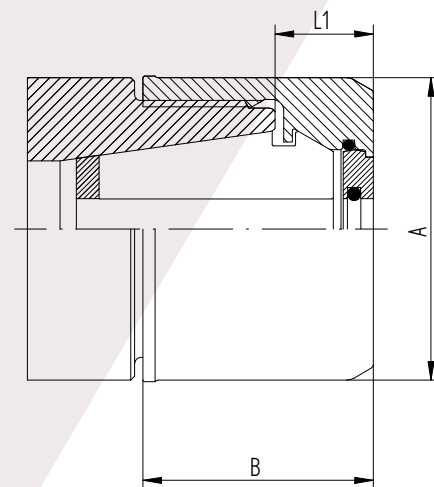

MRC

MR for MR colletholder

MRM for MR minicolletholders

MRC and MRMC for coolant through tools (DS/KS)

Type	Part no.	Dimensions [mm]		
		A	B	L1
MR 11				
Hi-Q / MR 11	3611.00000	16	16.2	4.5
MR 16				
Hi-Q / MR 16	3616.00000	28	23.1	6.7
MR 25				
Hi-Q / MR 25	3625.00000	40	25.5	8.1
MR 32				
Hi-Q / MR 32	3632.00000	50	31.8	9.1

Type	Part no.	Dimensions [mm]		
		A	B	L1
MRC 16				
Hi-Q / MRC 16	3616.20000	28	28.1	11.7
MRC 25				
Hi-Q / MRC 25	3625.20000	40	30.5	13.1
MRC 32				
Hi-Q / MRC 32	3632.20000	50	36.8	14.1

Type	Part no.	Dimensions [mm]		
		A	B	L1
MRM 16				
Hi-Q / MRM 16	3616.80000	24	23.1	6.7

Type	Part no.	Dimensions [mm]		
		A	B	L1
MRMC 16				
Hi-Q / MRMC 16	3616.90000	24	28.1	11.7

Affordable solution for internal cooling

Our sealing disks allow you to use your nonsealed micRun® collet for internal cooling, saving you acquisition costs for new collets.

Key advantages

Swiss quality product

Sealing range

0.5 mm

High pressure

For applications up to 2100 PSI.

Protection

Protects against all kind of dirt and chips entering the slots of the collet.

Matched tooling system for best fit

Our long-lasting machining experience results in a well-engineered system. All components are fitted together to one system to maximize your machining potential.

Coolant resistant

O-ring for aggressive coolant (MITON®-quality).

Interchangeable

Quick change of sealing disks according to required tool shank diameter.

Coolant through

For better cooling and lubrication. Extends tool life and supports chip removal.

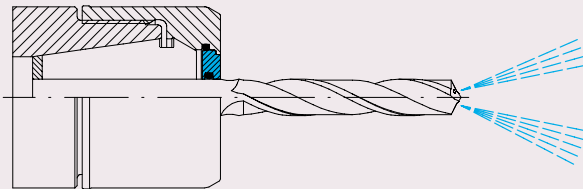

DS

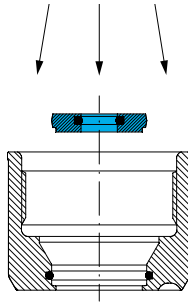

Assembling

Assembling Insert the small diameter of the disk into the center of the coolant nut. Apply an even pressure until the disk is properly seated into the nut.

The disk must be flush with the outside of the nut and the marking on the disk must be visible inside of the nut.

Removing To remove the disk, simply press on the outside of the disk evenly until it snaps out.

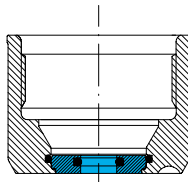

Inserted DS

Expert advice

Insert tool with the shank side first. O-ring might be damaged if cutting tool is inserted from the back with the cutting-edge side.

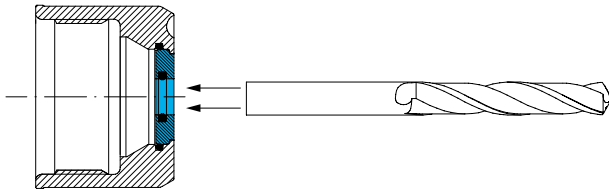

Insert tool

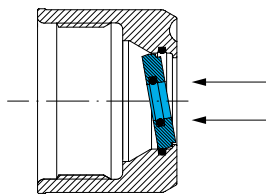

Disk removal

Type	Part no.	Ø [inch]	Bore Ø		Included in set
			[mm]	[inch]	
DS 16					
DS / ER 16 SET (14 Stk./ pcs.)	3916.00000	–	3.0 – 10.0	0.1378 – 0.3937	–
Ø 3.0 mm	3916.00300	3/32"	3.0 – 2.5	0.1181 – 0.0984	–
Ø 3.5 mm	3916.00350	1/8"	3.5 – 3.0	0.1378 – 0.1181	•
Ø 4.0 mm	3916.00400	5/32"	4.0 – 3.5	0.1575 – 0.1378	•
Ø 4.5 mm	3916.00450	–	4.5 – 4.0	0.1772 – 0.1575	•
Ø 5.0 mm	3916.00500	3/16"	5.0 – 4.5	0.1969 – 0.1772	•
Ø 5.5 mm	3916.00550	7/32"	5.5 – 5.0	0.2165 – 0.1969	•
Ø 6.0 mm	3916.00600	–	6.0 – 5.5	0.2362 – 0.2165	•
Ø 6.5 mm	3916.00650	1/4"	6.5 – 6.0	0.2559 – 0.2362	•
Ø 7.0 mm	3916.00700	–	7.0 – 6.5	0.2756 – 0.2559	•
Ø 7.5 mm	3916.00750	9/32"	7.5 – 7.0	0.2953 – 0.2756	•
Ø 8.0 mm	3916.00800	5/16"	8.0 – 7.5	0.315 – 0.2953	•
Ø 8.5 mm	3916.00850	–	8.5 – 8.0	0.3346 – 0.315	•
Ø 9.0 mm	3916.00900	11/32"	9.0 – 8.5	0.3543 – 0.3346	•
Ø 9.5 mm	3916.00950	3/8"	9.5 – 9.0	0.374 – 0.3543	•
Ø 10.0 mm	3916.01000	–	10.0 – 9.5	0.3937 – 0.374	•
DS 25					
DS / ER 25 SET (26 Stk./ pcs.)	3925.00000	–	3.0 – 16.0	0.1378 – 0.6299	–
Ø 3.0 mm	3925.00300	3/32"	3.0 – 2.5	0.1181 – 0.0984	–
Ø 3.5 mm	3925.00350	1/8"	3.5 – 3.0	0.1378 – 0.1181	•
Ø 4.0 mm	3925.00400	5/32"	4.0 – 3.5	0.1575 – 0.1378	•
Ø 4.5 mm	3925.00450	–	4.5 – 4.0	0.1772 – 0.1575	•
Ø 5.0 mm	3925.00500	3/16"	5.0 – 4.5	0.1969 – 0.1772	•
Ø 5.5 mm	3925.00550	7/32"	5.5 – 5.0	0.2165 – 0.1969	•
Ø 6.0 mm	3925.00600	–	6.0 – 5.5	0.2362 – 0.2165	•
Ø 6.5 mm	3925.00650	1/4"	6.5 – 6.0	0.2559 – 0.2362	•
Ø 7.0 mm	3925.00700	–	7.0 – 6.5	0.2756 – 0.2559	•
Ø 7.5 mm	3925.00750	9/32"	7.5 – 7.0	0.2953 – 0.2756	•
Ø 8.0 mm	3925.00800	5/16"	8.0 – 7.5	0.315 – 0.2953	•
Ø 8.5 mm	3925.00850	–	8.5 – 8.0	0.3346 – 0.315	•
Ø 9.0 mm	3925.00900	11/32"	9.0 – 8.5	0.3543 – 0.3346	•
Ø 9.5 mm	3925.00950	3/8"	9.5 – 9.0	0.374 – 0.3543	•
Ø 10.0 mm	3925.01000	–	10.0 – 9.5	0.3937 – 0.374	•
Ø 10.5 mm	3925.01050	13/32"	10.5 – 10.0	0.4134 – 0.3937	•
Ø 11.0 mm	3925.01100	–	11.0 – 10.5	0.4331 – 0.4134	•
Ø 11.5 mm	3925.01150	7/16"	11.5 – 11.0	0.4528 – 0.4331	•
Ø 12.0 mm	3925.01200	15/32"	12.0 – 11.5	0.4724 – 0.4528	•
Ø 12.5 mm	3925.01250	–	12.5 – 12.0	0.4921 – 0.4724	•
Ø 13.0 mm	3925.01300	1/2"	13.0 – 12.5	0.5118 – 0.4921	•

Type	Part no.	Ø [inch]	Bore Ø		Included in set
			[mm]	[inch]	
Ø 13.5 mm	3925.01350	17/32"	13.5 – 13.0	0.5315 – 0.5118	•
Ø 14.0 mm	3925.01400	–	14.0 – 13.5	0.5512 – 0.5315	•
Ø 14.5 mm	3925.01450	9/16"	14.5 – 14.0	0.5709 – 0.5512	•
Ø 15.0 mm	3925.01500	–	15.0 – 14.5	0.5906 – 0.5709	•
Ø 15.5 mm	3925.01550	19/32"	15.5 – 15.0	0.6102 – 0.5906	•
Ø 16.0 mm	3925.01600	5/8"	16.0 – 15.5	0.6299 – 0.6102	•

DS 32

DS / ER 32 SET (34 Stk. / pcs.)	3932.00000	–	3.0 – 20.0	0.1378 – 0.7874	–
Ø 3.0 mm	3932.00300	3/32"	3.0 – 2.5	0.1181 – 0.0984	–
Ø 3.5 mm	3932.00350	1/8"	3.5 – 3.0	0.1378 – 0.1181	•
Ø 4.0 mm	3932.00400	5/32"	4.0 – 3.5	0.1575 – 0.1378	•
Ø 4.5 mm	3932.00450	–	4.5 – 4.0	0.1772 – 0.1575	•
Ø 5.0 mm	3932.00500	3/16"	5.0 – 4.5	0.1969 – 0.1772	•
Ø 5.5 mm	3932.00550	7/32"	5.5 – 5.0	0.2165 – 0.1969	•
Ø 6.0 mm	3932.00600	–	6.0 – 5.5	0.2362 – 0.2165	•
Ø 6.5 mm	3932.00650	1/4"	6.5 – 6.0	0.2559 – 0.2362	•
Ø 7.0 mm	3932.00700	–	7.0 – 6.5	0.2756 – 0.2559	•
Ø 7.5 mm	3932.00750	9/32"	7.5 – 7.0	0.2953 – 0.2756	•
Ø 8.0 mm	3932.00800	5/16"	8.0 – 7.5	0.315 – 0.2953	•
Ø 8.5 mm	3932.00850	–	8.5 – 8.0	0.3346 – 0.315	•
Ø 9.0 mm	3932.00900	11/32"	9.0 – 8.5	0.3543 – 0.3346	•
Ø 9.5 mm	3932.00950	3/8"	9.5 – 9.0	0.374 – 0.3543	•
Ø 10.0 mm	3932.01000	–	10.0 – 9.5	0.3937 – 0.374	•
Ø 10.5 mm	3932.01050	13/32"	10.5 – 10.0	0.4134 – 0.3937	•
Ø 11.0 mm	3932.01100	–	11.0 – 10.5	0.4331 – 0.4134	•

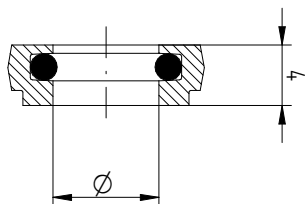

DS

Type	Part no.	Ø [inch]	Bore Ø		Included in set
			[mm]	[inch]	
DS 32 continued					
Ø 11.5 mm	3932.01150	7/16"	11.5 – 11.0	0.4528 – 0.4331	•
Ø 12.0 mm	3932.01200	15/32"	12.0 – 11.5	0.4724 – 0.4528	•
Ø 12.5 mm	3932.01250	–	12.5 – 12.0	0.4921 – 0.4724	•
Ø 13.0 mm	3932.01300	1/2"	13.0 – 12.5	0.5118 – 0.4921	•
Ø 13.5 mm	3932.01350	17/32"	13.5 – 13.0	0.5315 – 0.5118	•
Ø 14.0 mm	3932.01400	–	14.0 – 13.5	0.5512 – 0.5315	•
Ø 14.5 mm	3932.01450	9/16"	14.5 – 14.0	0.5709 – 0.5512	•
Ø 15.0 mm	3932.01500	–	15.0 – 14.5	0.5905 – 0.5709	•
Ø 15.5 mm	3932.01550	19/32"	15.5 – 15.0	0.6102 – 0.5906	•
Ø 16.0 mm	3932.01600	5/8"	16.0 – 15.5	0.6299 – 0.6102	•
Ø 16.5 mm	3932.01650	–	16.5 – 16.0	0.6496 – 0.6299	•
Ø 17.0 mm	3932.01700	21/32"	17.0 – 16.5	0.6693 – 0.6496	•
Ø 17.5 mm	3932.01750	11/16"	17.5 – 17.0	0.689 – 0.6693	•
Ø 18.0 mm	3932.01800	–	18.0 – 17.5	0.7087 – 0.689	•
Ø 18.5 mm	3932.01850	23/32"	18.5 – 18.0	0.7283 – 0.7087	•
Ø 19.0 mm	3932.01900	3/4"	19.0 – 18.5	0.748 – 0.7283	•
Ø 19.5 mm	3932.01950	–	19.5 – 19.0	0.7677 – 0.748	•
Ø 20.0 mm	3932.02000	25/32"	20.0 – 19.5	0.7874 – 0.7677	•

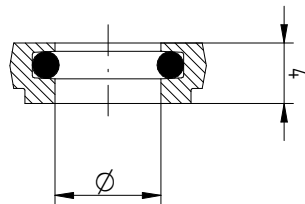

DS



We manufacture products we can be proud of. Together we aim for excellence in every step we take: from the inspiring idea to the finished product.

Passion for precision

Our solution for peripheral cooling

The design of our coolant flush disks leads the coolant along the edge of the cutting tool, providing you with an easy way to achieve peripheral cooling.

Key advantages

Swiss quality product

Marking

Type and size (reduced disk selection errors).

Traceability

Lot number marking on all products for traceability through the entire manufacturing process.

Original REGO-FIX

Our long-lasting machining experience results in a well-engineered system. When buying ER coolant flush disks please pay attention to the REGO-FIX quality seal on the coolant flush disk: The triangle is our seal for outstanding quality made in Switzerland.

Universal use

For all REGO-FIX collets and coolant nuts with interchangeable disk.

Interchangeable

Quick change of coolant flush disks according to required tool shank diameter.

Peripheral cooling

For better cooling and lubrication.
Extends tool life and supports chip removal.

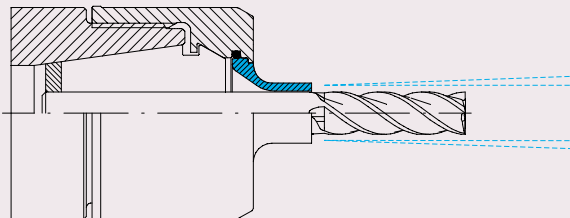

KS

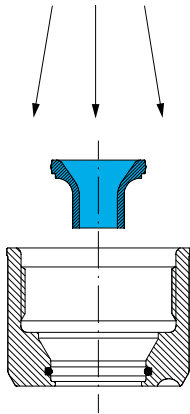

Assembling

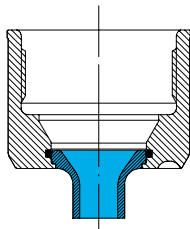

Inserted KS

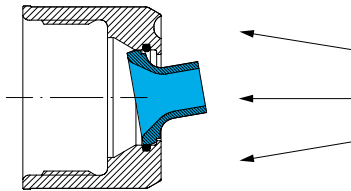

Removing

Assembling Insert the small diameter of the disk into the center of the coolant nut. Apply an even pressure until the disk is properly seated into the nut.

The disk must be flush with the outside of the nut and the marking on the disk must be visible inside of the nut.

Removing To remove the disk, simply press on the outside of the disk evenly until it snaps out.

Type	Part no.	Dimensions [mm]		Ø	
		D	L	[mm]	[inch]
KS 16 [mm]					
Ø 3.0 mm	3916.20300	6.4	11	3	–
Ø 4.0 mm	3916.20400	7.4	11	4	–
Ø 5.0 mm	3916.20500	8.4	11	5	–
Ø 6.0 mm	3916.20600	9.4	11	6	–
Ø 7.0 mm	3916.20700	11	11	7	–
Ø 8.0 mm	3916.20800	11	11	8	–
Ø 9.0 mm	3916.20900	11	2	9	–
Ø 10.0 mm	3916.21000	11	2	10	–
BLANK KS 16 Ø 11 x 12*	3916.29999	11	12	–	–

KS 16 [inch]					
Ø 1/8"	3916.30318	6.6	11	3.175	1/8"
Ø 3/16"	3916.30476	8.2	11	4.763	3/16"
Ø 1/4"	3916.30635	9.7	11	6.35	1/4"
Ø 5/16"	3916.30794	11	11	7.938	5/16"
Ø 3/8"	3916.30953	11	2	9.525	3/8"

KS 25 [mm]					
Ø 3.0 mm	3925.20300	6.4	11	3	–
Ø 4.0 mm	3925.20400	7.4	11	4	–
Ø 5.0 mm	3925.20500	8.4	11	5	–
Ø 6.0 mm	3925.20600	9.4	11	6	–
Ø 7.0 mm	3925.20700	10.4	11	7	–
Ø 8.0 mm	3925.20800	11.4	11	8	–
Ø 9.0 mm	3925.20900	12.4	11	9	–
Ø 10.0 mm	3925.21000	13.4	11	10	–
Ø 12.0 mm	3925.21200	15.4	11	12	–
Ø 14.0 mm	3925.21400	17.4	11	14	–
Ø 16.0 mm	3925.21600	19	11	16	–
BLANK KS 25 Ø 19 x 12*	3925.29999	19	12	–	–

* Work material: 42CrMoS4 (1.7227).

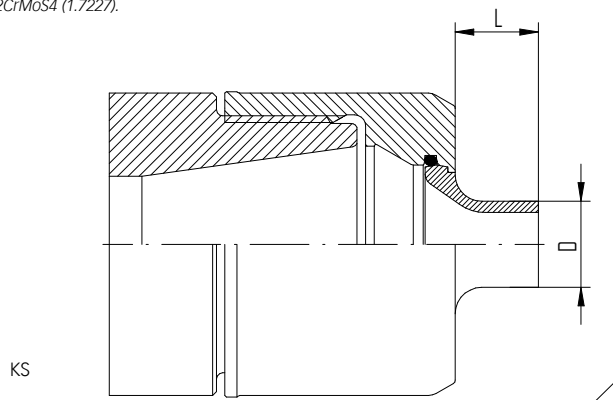

Type	Part no.	Dimensions [mm]			Ø	
		D	L	[mm]	[inch]	
KS 25 [inch]						
Ø 1/8"	3925.30318	6.6	11	3.175	1/8"	
Ø 3/16"	3925.30476	8.2	11	4.763	3/16"	
Ø 1/4"	3925.30635	9.7	11	6.35	1/4"	
Ø 5/16"	3925.30794	11.3	11	7.938	5/16"	
Ø 3/8"	3925.30953	12.9	11	9.525	3/8"	
Ø 7/16"	3925.31111	14.5	11	11.113	7/16"	
Ø 1/2"	3925.31270	16.1	11	12.7	1/2"	
Ø 9/16"	3925.31429	17.7	11	14.288	9/16"	
Ø 5/8"	3925.31588	19	11	15.875	5/8"	

KS 32 [mm]						
Ø 3.0 mm	3932.20300	6.4	11	3	-	
Ø 4.0 mm	3932.20400	7.4	11	4	-	
Ø 5.0 mm	3932.20500	8.4	11	5	-	
Ø 6.0 mm	3932.20600	9.4	11	6	-	
Ø 7.0 mm	3932.20700	10.4	11	7	-	
Ø 8.0 mm	3932.20800	11.4	11	8	-	
Ø 9.0 mm	3932.20900	12.4	11	9	-	
Ø 10.0 mm	3932.21000	13.4	11	10	-	
Ø 12.0 mm	3932.21200	15.4	11	12	-	
Ø 14.0 mm	3932.21400	17.4	11	14	-	
Ø 16.0 mm	3932.21600	19.4	11	16	-	
Ø 18.0 mm	3932.21800	21.4	11	18	-	
Ø 20.0 mm	3932.22000	24	11	20	-	
BLANK KS 32 Ø 24 x 12*	3932.29999	24	12	-	-	

KS 32 [inch]						
Ø 1/8"	3932.30318	6.6	11	3.175	1/8"	
Ø 3/16"	3932.30476	8.2	11	4.763	3/16"	
Ø 1/4"	3932.30635	9.7	11	6.35	1/4"	
Ø 5/16"	3932.30794	11.3	11	7.938	5/16"	
Ø 3/8"	3932.30953	12.9	11	9.525	3/8"	
Ø 7/16"	3932.31111	14.5	11	11.113	7/16"	
Ø 1/2"	3932.31270	16.1	11	12.7	1/2"	
Ø 9/16"	3932.31429	17.7	11	14.288	9/16"	
Ø 5/8"	3932.31588	19.3	11	15.875	5/8"	
Ø 3/4"	3932.31905	24	11	19.05	3/4"	

* Work material: 42CrMoS4 (1.7227).



Contents

micRun[®] accessories

Enhance your tool life with the proper accessories for safe toolholding.

Torque wrenches TORCO-FIX	44
Freewheel wrench heads A-FLS	44
Grip bar for wrench heads G-A	44
Trays for MR collets ZWT	45
Trays for sealing disk sets DSR	45
Coolant tubes KSR	46
Wrenches for coolant tubes SKR	46
Toolholding fixtures	47



Torque wrenches

Freewheel wrench heads A-FLS

Grip bar for wrench heads G-A

Type	Part no.	L1 [mm]	Range [ft-lbs]
Torque wrenches			
Micro	7150.02025	290	2.0–25.0
Small	8020.10050	300	7.5-37.0
Medium	8020.20100	340	15.0-80.0
Large	8020.60300	545	45.0-220.0

Type	Part no.	D [mm]	D1 [mm]
Freewheel wrench heads A-FLS			
A-FLS Ø 16 / MR 11	7855.11000	16	34
A-FLS Ø 28 / MR 16	7855.16000	28	47
A-FLS Ø 24 / MRM 16	7855.16800	24	47
A-FLS Ø 40 / MR 25	7855.25000	40	61
A-FLS Ø 50 / MR 32	7855.32000	50	77

Grip bar for wrench heads G-A			
G-A	7655.99900	–	–

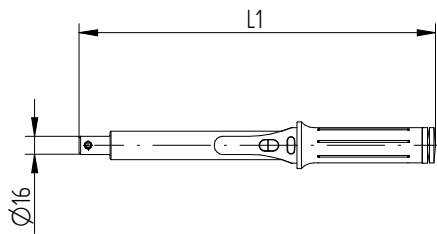

Torque wrench

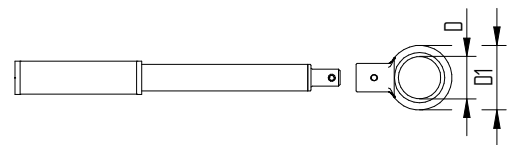

G-A with A-FLS

Trays for MR collets ZWT

Trays for sealing disk sets DSR

Type	Part no.	Fits ... items
Trays for MR collets ZWT		
ZWT 16	0712.11600	10
ZWT 25	0712.12500	15
ZWT 32	0712.13200	18

Trays for sealing disk sets DSR		
DSR 16	0712.21600	14
DSR 25	0712.22500	26
DSR 32	0712.23200	34

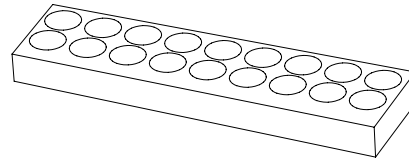

ZWT

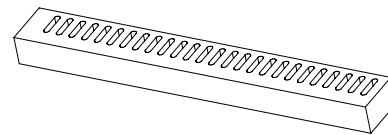

DSR

Expert advice

To ensure a clearly arranged display and easy handling, the sealing disk bore diameters or collet diameters are marked on the tray.

Coolant tubes KSR

Wrenches for coolant tubes SKR

KSR

SKR

Type	Part no.	Dimensions [mm]			G
		D	L	L1	
Coolant tubes KSR					
KSR 25	7211.25000	5	4.5	17	M 8 x 1
KSR 32	7211.32000	6	5.5	25.7	M 10 x 1
KSR 40	7211.40000	8	7.5	29.2	M 12 x 1
KSR 50	7211.50000	10	9.5	32.7	M 16 x 1
KSR 63	7211.63000	12	11.5	36.2	M 18 x 1
KSR 80	7211.80000	14	13.5	39.7	M 20 x 1.5
KSR 100	7211.00000	16	15.5	43.6	M 24 x 1.5
KSR 125	7211.12500	16	15.5	43.6	M 24 x 1.5

Type	Part no.
Wrenches SKR	
SKR 25	7212.25000
SKR 32	7212.32000
SKR 40	7212.40000
SKR 50	7212.50000
SKR 63	7212.63000
SKR 80	7212.80000
SKR 100	7212.00000
SKR 125	7212.12500

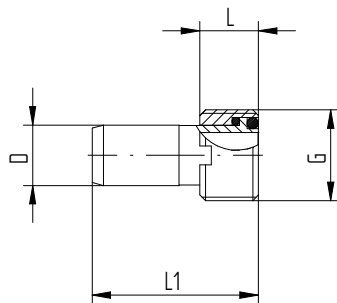

KSR

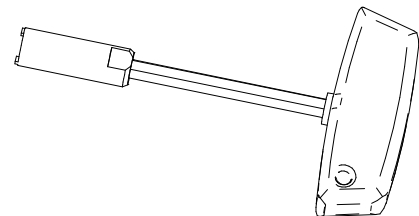

SKR

Type	Part no.	Fits this interface
Tool assembly WMH		
WMH-AC 45°	7813.00000	–
WMH-AC 90°	7813.00100	–

Tool adapter WA / SK		
WA / SK 30	7814.30100	BT / CAT / SK 30
WA / SK 40	7814.40100	BT / CAT / SK 40

Tool adapter WA / HSK-A / C / E		
WA / HSK-A / C / E 25	7814.25300	HSK-A / C / E 25

Tool adapter WA / HSK-A		
WA / HSK-A 32	7814.32200	HSK-A 32
WA / HSK-A 40	7814.40200	HSK-A 40
WA / HSK-A 50	7814.50200	HSK-A 50
WA / HSK-A 63	7814.63200	HSK-A 63

Tool adapter WA / HSK-C / E		
WA / HSK-C / E 32	7814.32500	HSK-C / E 32
WA / HSK-C / E 40	7814.40500	HSK-C / E 40
WA / HSK-C / E 50	7814.50500	HSK-C / E 50

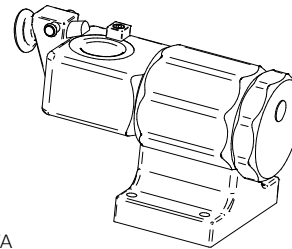

WMH / WA

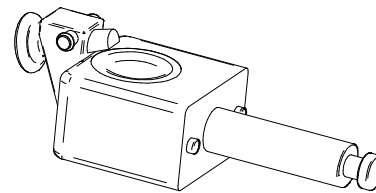

WA



Contents

Technical information

Recommended tightening torque for MR clamping nuts	50
MR collet dimensions	50
Spindle interface norms	51



CAUTION: LASER PRODUCT
CLASS 2B WARNING
LASER RADIATION WHEN OPEN
AND LOCKS DEFEATED
AVOID EXPOSURE TO BEAM

HENSCH technology

Recommended tightening torque for MR clamping nuts

MR collets dimensions

Collet size	Ø [mm]	Ø [inch]	micRun® clamping nuts				Torque Wrench
			MR/MRC		MRM/MRMC		
			MR	MRC	MRM	MRMC	
MR 11	1.0–2.9	0.039–0.098	8	8	–	–	Micro, S
	3.0–7.0	0.118–0.256	16	16	–	–	Micro, S
MR 16	1.0	0.039	8	8	8	8	Micro, S
	1.5–3.5	0.059–0.138	20	20	20	20	Micro, S
	4.0–4.5	0.157–0.177	40	40	24	24	S, M
MR 20	5.0–10.0	0.197–0.394	56	56	24	24	S, M
	1.0	0.039	16	16	–	–	Micro, S
	1.5–6.5	0.059–0.256	32	32	–	–	S, M
MR 25	7.0–13.0	0.276–0.512	80	80	–	–	S, M
	1.0–3.5	0.059–0.138	24	24	–	–	S
	4.0–4.5	0.157–0.177	56	56	–	–	S, M
MR 32	5.0–7.5	0.196–0.295	80	80	–	–	M, L
	8.0–17.0	0.315–0.669	104	80	–	–	M, L
	2.0–2.5	0.078–0.098	24	24	–	–	Micro, S
	3.0–22.0	0.118–0.2917	136	136	–	–	M, L

Size [mm]	Measurements [mm]										
D2	d	D1	D2	D3	D4	L	L1	L2	L3	L4	Drawing
MR 11	1.0–2.0	11.5	11	9.5	5	18	3.8	2	2.5	9	1
MR 11	3.0–6.35	11.5	11	9.5	–	18	3.8	2	2.5	–	2
MR 16	1.0	17	16	13.8	7.5	27.5	6.26	2.7	4	13	1
MR 16	2.0–4.0	17	16	13.8	7.5	27.5	6.26	2.7	4	10	1
MR 16	5.0–10.0	17	16	13.8	–	27.5	6.25	2.7	4	–	2
MR 25	1.0	26	25	22	12	34	6.66	3.1	5	18	1
MR 25	2.0–6.35	26	25	22	12	34	6.66	3.1	5	15	1
MR 25	8.0–16.0	26	25	22	–	34	6.66	3.1	5	–	2
MR 32	2.0–4.0	33	32	29.2	15	40	7.2	3.6	5.5	20	1
MR 32	5.0–6.35	33	32	29.2	15	40	7.2	3.6	5.5	15	1
MR 32	8.0–20.0	33	32	29.2	–	40	7.2	3.6	5.5	–	2

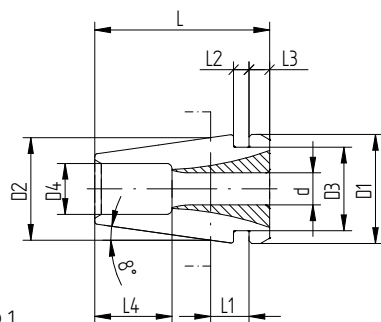

Drawing No 1

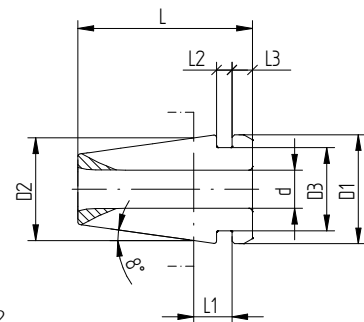

Drawing No 2

Spindle interface norms

SK	BT	HSK
DIN 69871	MAS 403	DIN 69893

Type	Measurements [mm]					G
	D1	D2	L1	L2	L3	
SK DIN 69871						
SK 30	31.75	50	3.2	47.8	15.85	M 12
SK 40	44.45	63.55	3.2	68.4	15.85	M 16
SK 50	69.85	97.5	3.2	101.75	15.85	M 24
BT MAS 403						
BT 30	31.75	46	2	48.4	20	M 12
BT 40	44.45	63	2	65.4	25	M 16
BT 50	69.85	100	3	101.8	35	M 24
HSK DIN 69893						
HSK-A 25	25	19	10	13	2.5	-
HSK-E 25	25	19	10	13	2.5	-
HSK-A 32	32	24	20	16	3.2	-
HSK-E 32	32	24	20	16	3.2	-
HSK-A 40	40	30	20	20	4	-
HSK-E 40	40	30	20	20	4	-
HSK-A 50	50	38	26	25	5	-
HSK-E 50	50	38	26	25	5	-
HSK-A 63	63	48	26	32	6.3	-
HSK-E 63	63	48	26	32	6.3	-
HSK-A 80	80	60	26	40	8	-

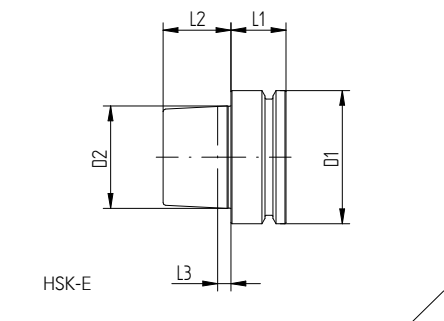
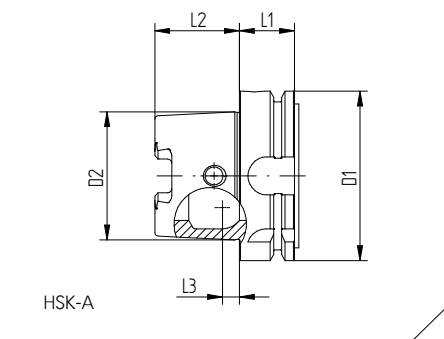
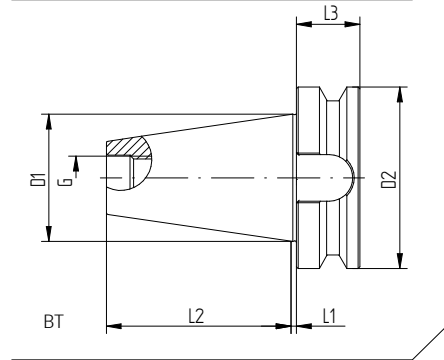
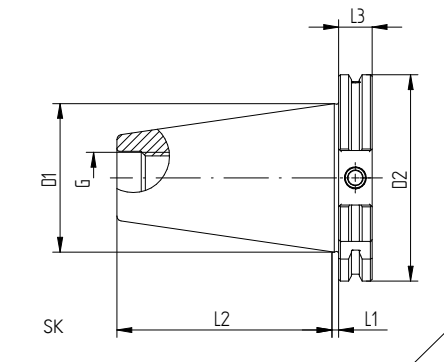

Get in touch

We love to talk to you and share our toolholding expertise to maximize your productivity.

REGO-FIX Tool Corp.

7752 Moller Road / Indianapolis / IN 46268 / USA
Toll Free 800-999-7346 / Phone 317-870-5959 / Fax 317-870-5955
info@rego-fix.com / www.rego-fix.com

Printed by Gmähle-Scheel Print-Medien GmbH
Printed on Arctic Highwhite
Arctic Highwhite is FSC certified for sustainable forestry.

REGO-FIX AG is ISO certified:
ISO 9001 for quality management / since 1996
ISO 14001 for environmental management / since 2007

This document should not be used or relied on for any purpose other than that intended by REGO-FIX AG.
No part of this document may be reproduced or transmitted in any other form without the express written permission of REGO-FIX AG.

The data given in this catalog are dependent on the conditions under which they are measured and are derived from tests carried out under defined lab conditions at REGO-FIX AG. The performance of these tools depends on the conditions under which they are used and may vary from case to case. The information given in this catalog is believed to be correct. REGO-FIX AG however assumes no responsibility or liability for any errors, inaccuracies or omissions that may appear in this catalog. Information in this catalog is subject to change without notice and should not be construed as a commitment by REGO-FIX AG or its subsidiaries. This is especially valid for adaptations to new or changed international standards or improvements to the products performance or production processes.

Viton® is a brand of synthetic rubber and fluoropolymer elastomer of DuPont Performance Elastomers.

© Copyright 2016 REGO-FIX Tool Corp.





Swiss quality standard

Our products marked Swiss made are manufactured at our headquarters in Tenniken, Switzerland.

